

10W

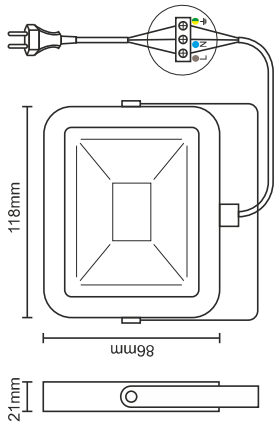

art.nr.: LF2021

тип: F02-10/4000K/BK

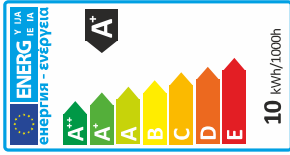

1/20



10W

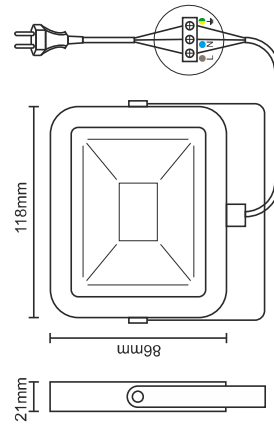
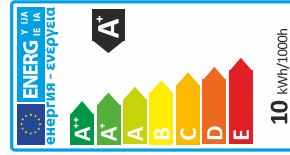

art.nr.: LF2121

тип: F02-10/4000K/WH

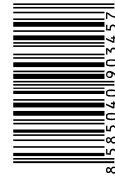

1/20



MOI

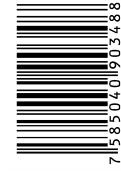
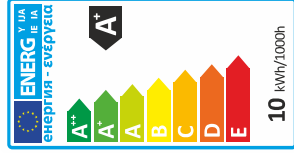
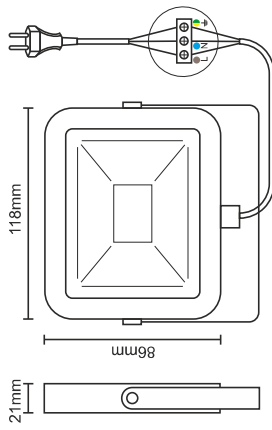

art.ni.: LF2221

tup: F02-1D/4000K/GY

IP65

IK08

4000K

900lm

10W
90W

-25°C
+45°C

AC
200-255V

120°

30,000 h

25,000

9%
100%

Ra
≥ 80

UV
free

1/20



MOI

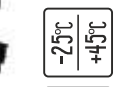
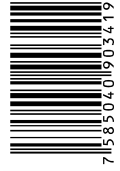
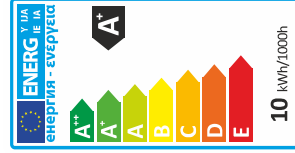
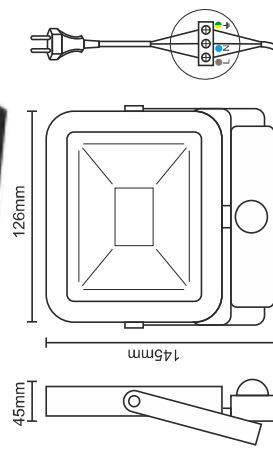

art.ni.: LF2021S

tup: F02-1D/4000K/BK/PS

IP65

IK08

4000K

900lm

10W
90W

-25°C
+45°C

AC
200-255V

120°

30,000 h

25,000

9%
100%

Ra
≥ 80

UV
free

1/20

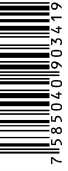

20W

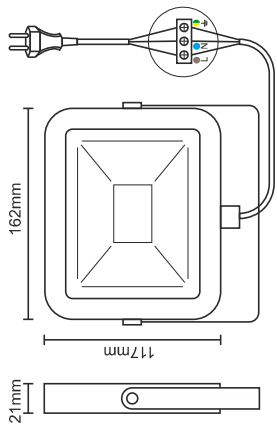

art.nr.: LF2022

tup: F02-20/4000K/BK

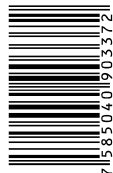

- IP65
- IK08
- 4000K
- 1800lm
- 20W
- 1800W
- 25°C
- +45°C
- AC
- 200-265V
- 120°
- 30,000 h
- 25,000
- 0%
- 100%
- Ra ≥ 80
- UV free

20W

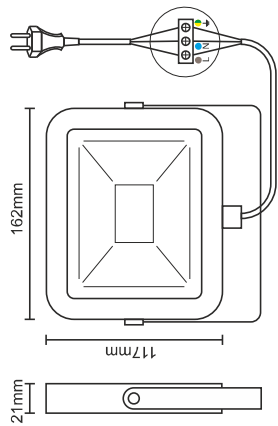

art.nr.: LF2122

tup: F02-20/4000K/WH

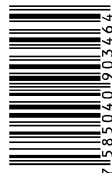

- IP65
- IK08
- 4000K
- 1800lm
- 20W
- 1800W
- 25°C
- +45°C
- AC
- 200-265V
- 120°
- 30,000 h
- 25,000
- 0%
- 100%
- Ra ≥ 80
- UV free

20W

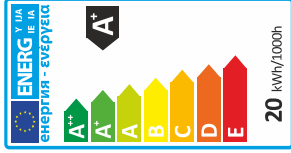
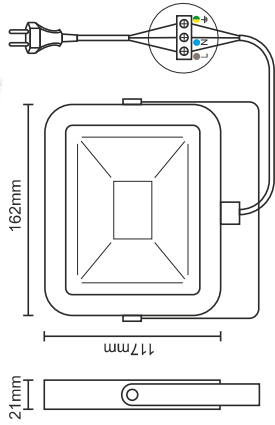

art.ni.: LF2222

tup: F02-20/4000K/GY

IP65

IK08

4000K

1800lm

20W
180W

-25°C
+45°C

AC
200-265V

120°

30,000 h

25,000

9% 100%

UV free

Ra ≥ 80

1/20



715850401903495

20W

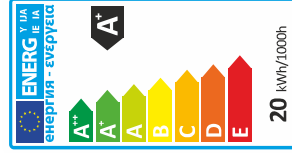
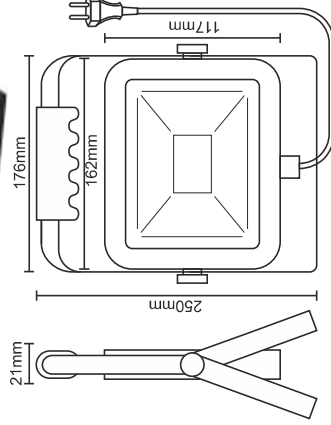

art.ni.: LF2022H

tup: F02-20/4000K/BK/H

IP65

IK08

4000K

1800lm

20W
180W

-25°C
+45°C

AC
200-265V

120°

30,000 h

25,000

9% 100%

UV free

Ra ≥ 80

1/10



715850401903594

20W

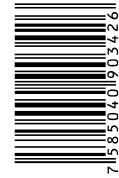
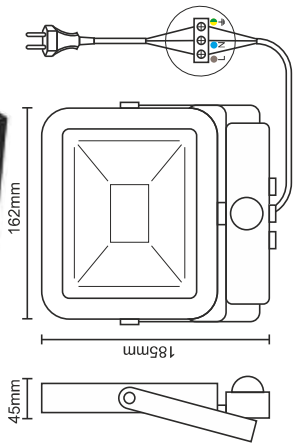
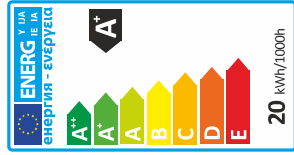

1 / 20

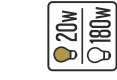

art.nr.: LF2022S

tup: F02-20/4000K/BK/PS



20W

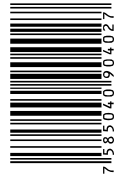
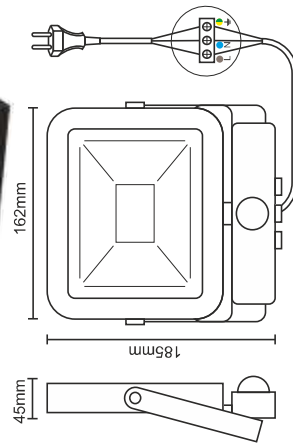
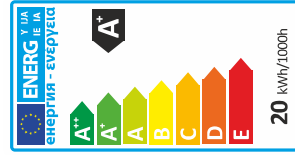

1 / 20

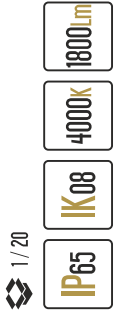

art.nr.: LF2122S

tup: F02-20/4000K/WH/PS



20W

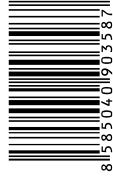
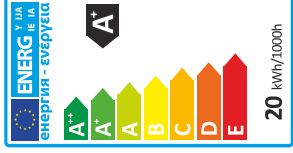
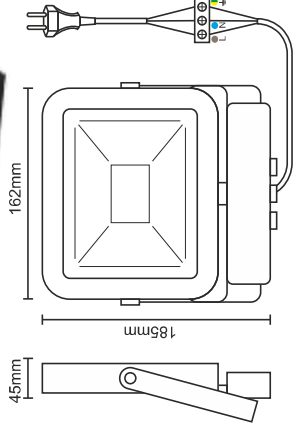

1/20



art.nr.: LF2022MS

tip: F02-20/4000K/BK/MS



30W

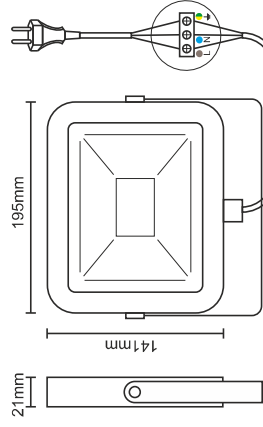

1/10



art.nr.: LF2023

tip: F02-30/4000K/BK



30W

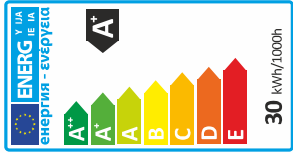
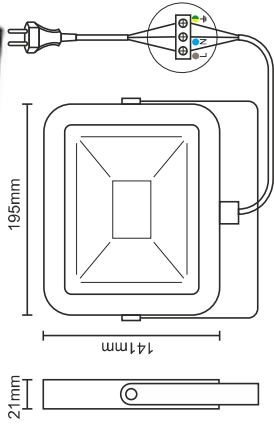

art.nr.: LF2123

тип: F02-30/4000K/WH



1/10

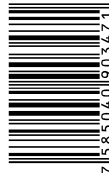

7 158 504 019 034 71

30W

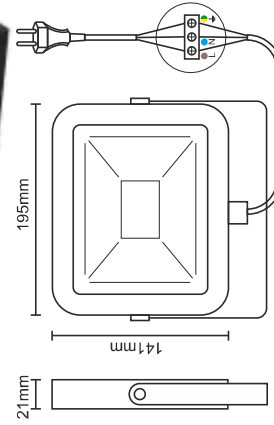

art.nr.: LF2223

тип: F02-30/4000K/GY



1/10



7 158 504 019 035 011

300



art.ni.: LF2023H

tup: F02-30/4000K/BK/H

IP65

IK08

4000K

2700.Lm

30W
270W

-25°C
+45°C

AC
200-255V

120°

30,000 h

25,000

9% 100%

UV free

Ra ≥ 80

1/10



815850401903601

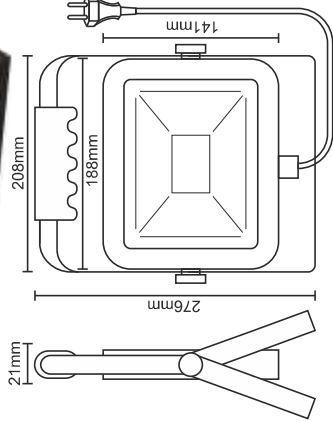

300



art.ni.: LF2023S

tup: F02-30/4000K/BK/PS

IP65

IK08

4000K

2700.Lm

30W
270W

-25°C
+45°C

AC
200-255V

120°

30,000 h

25,000

9% 100%

UV free

Ra ≥ 80

1/10

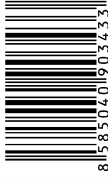

815850401903431

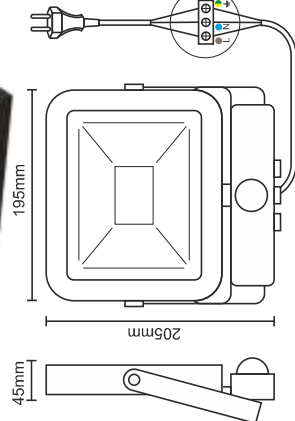

50W

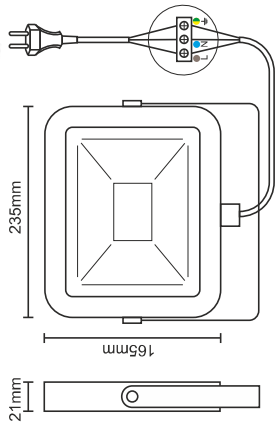
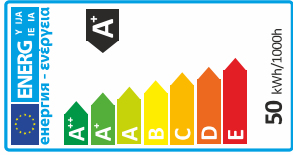

art.nr.: LF2024

tup: F02-50/4000K/BK



1/10

- IP65
- IK08
- 4000K
- 4500Lm
- 50W / 450W
- 25°C / +45°C
- AC 200-265V
- 120°
- 30,000 h
- 25,000
- 0% / 100%
- Ra ≥ 80
- UV free

50W

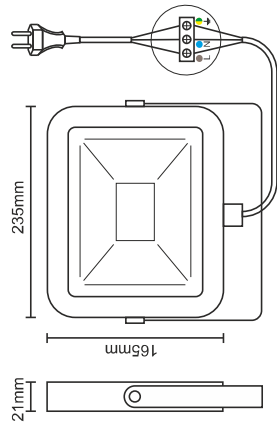
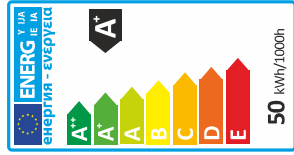

art.nr.: LF2124

tup: F02-50/4000K/WH

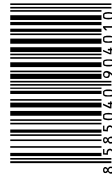

1/10

- IP65
- IK08
- 4000K
- 4500Lm
- 50W / 450W
- 25°C / +45°C
- AC 200-265V
- 120°
- 30,000 h
- 25,000
- 0% / 100%
- Ra ≥ 80
- UV free



art.nr.: LF2024H

tup: F02-50/4000K/BK/H

IP65

IK08

4000K

4500.Lm

50W
450W

-25°C
+45°C

AC
200-255V

120°

30.000 h

25.000

9% 100%

UV free

Ra ≥ 80

1/10



815850401903617

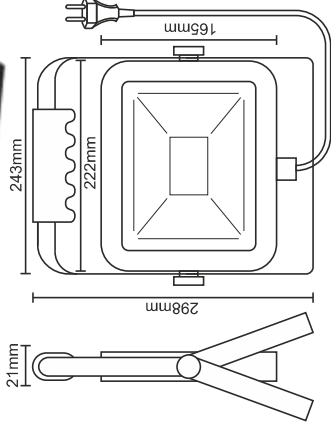
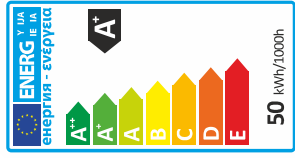

50W



art.nr.: LF2024S

tup: F02-50/4000K/BK/PS

IP65

IK08

4000K

4500.Lm

50W
450W

-25°C
+45°C

AC
200-255V

120°

30.000 h

25.000

9% 100%

UV free

Ra ≥ 80

1/10

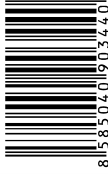

8158504019034401

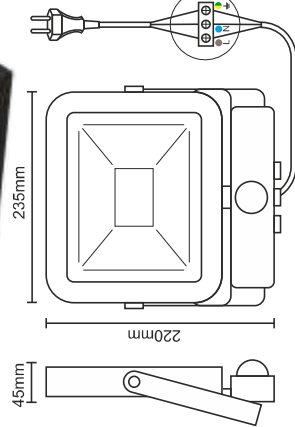
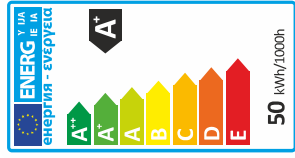

50W

100W

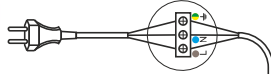
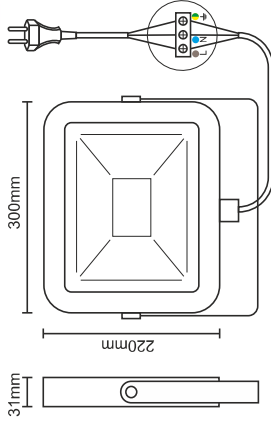
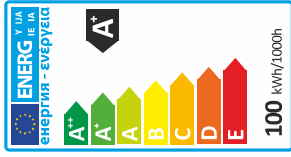

art.nr.: LF2025

tup: F02-100/4000K/BK

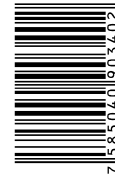

1/5

- IP65
- IK08
- 4000K
- 8500lm
- 100W / 850W
- 25°C / +45°C
- AC 200-265V
- 120°
- 30,000 h
- 25,000
- 0% / 100%
- Ra ≥ 80
- UV free

ACCESS. BRACKET



USED FOR:
LFZ series (10-100W)

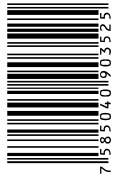

1/18

art.nr.: BB01

tup: BIB/80/BK

