

drátěný žlab s integrovanou spojkou

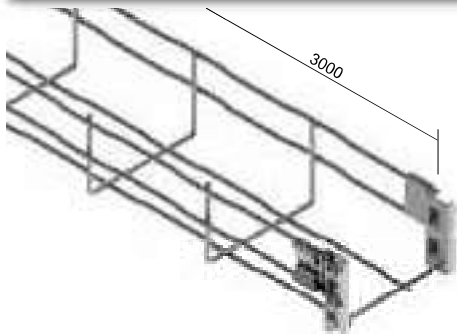

- ▶ Každý drátěný žlab je na jednom konci osazen spojkami - do šířky 200 mm jsou spojky na bočnicích, od šířky 300 mm jsou spojky na bočnicích i ve dně žlabu.
- ▶ Spojení se provádí (viz str. 4-3). Toto spojení splňuje vodivé pospojení.
- ▶ S ohledem na větrání kabelů je doporučena montáž žlabů se vzdáleností 250 mm od sebe a 20 mm od stěny.

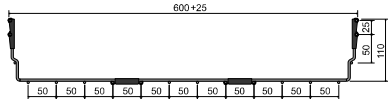
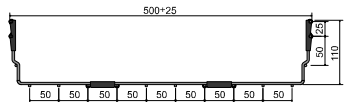
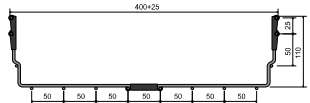
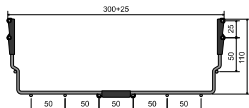
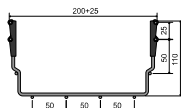
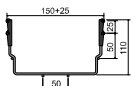
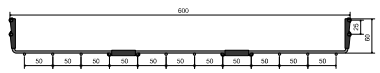
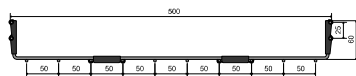
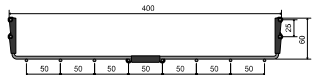
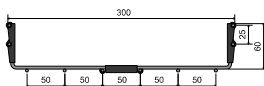
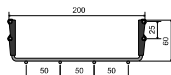
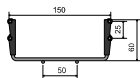
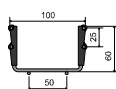
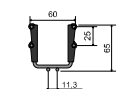

položka	Ø	☒	‡	spojovací část ve dně žlabu	EAN
● DZI 60X60_BZNCR	3,9	21	0,75	0	8595568927859
⊕ DZI 60X60_BEZN	3,9	21	0,75	0	8595568931252
⊕ INOXDZI 60X60_BIX*	4,0	21	0,59	0	8595568931399
● DZI 60X100_BZNCR	3,9	43	0,79	0	8595568927866
⊕ DZI 60X100_BEZN	3,9	43	0,79	0	8595568931269
⊕ INOXDZI 60X100_BIX	4,0	43	0,82	0	8595568931405
● DZI 60X150_BZNCR	3,9	72	0,84	0	8595568927873
⊕ DZI 60X150_BEZN	3,9	72	0,84	0	8595568931276
⊕ INOXDZI 60X150_BIX	4,0	72	0,88	0	8595568931412
● DZI 60X200_BZNCR	3,9	100	1,09	0	8595568927880
⊕ DZI 60X200_BEZN	3,9	100	1,09	0	8595568931283
⊕ INOXDZI 60X200_BIX	4,0	100	1,13	0	8595568931429
● DZI 60X300_BZNCR	4,3	156	1,58	1	8595568927897
⊕ DZI 60X300_BEZN	4,3	156	1,58	1	8595568931290
⊕ INOXDZI 60X300_BIX	4,4	156	1,74	1	8595568931436
● DZI 60X400_BZNCR	4,3	212	2,01	1	8595568927903
⊕ DZI 60X400_BEZN	4,3	212	2,01	1	8595568931306
● DZI 60X500_BZNCR	4,6	268	2,72	2	8595568927910
⊕ DZI 60X500_BEZN	4,6	268	2,72	2	8595568931313
● DZI 60X600_BZNCR	4,6	324	3,13	2	8595568927927
⊕ DZI 60X600_BEZN	4,6	324	3,13	2	8595568931320
⊕ DZI 110X150_BZNCR	4,3	133	1,14	0	8595568931221
⊕ DZI 110X150_BEZN	4,3	133	1,14	0	8595568931337
● DZI 110X200_BZNCR	4,3	186	1,59	0	8595568927934
⊕ DZI 110X200_BEZN	4,3	186	1,59	0	8595568931344
● DZI 110X300_BZNCR	4,3	291	2,04	1	8595568927941
⊕ DZI 110X300_BEZN	4,3	291	2,04	1	8595568931351
● DZI 110X400_BZNCR	4,6	396	2,71	1	8595568927958
⊕ DZI 110X400_BEZN	4,6	396	2,71	1	8595568931368
⊕ DZI 110X500_BZNCR	4,6	501	3,12	2	8595568931238
⊕ DZI 110X500_BEZN	4,6	501	3,12	2	8595568931375
⊕ DZI 110X600_BZNCR	4,6	606	3,53	2	8595568931245
⊕ DZI 110X600_BEZN	4,6	606	3,53	2	8595568931382

* žlab INOXDZI 60X60_BIX nemá dráty ve dně.

Ø průměr drátu (mm)

‡ hmotnost kg/m

● standard

BEZN elektrolytické zinkování s vyšší ochranou

BZNCR zinkochromát

☒ vnitřní využitelný průřez (cm²)

⊕ na objednávku

BIX nerez