

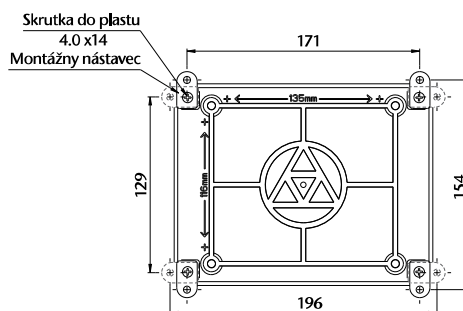

Zásuvkové rozvodnice ROSPG (Praktik)

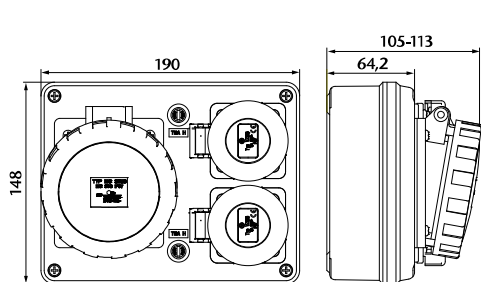

Montážny nástavec



Poznámka: Montážne nástavce a skrutky sú súčasťou dodávky rozvodnice ROSPG.

ROSPG - IP 67

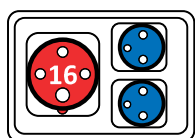

ROSPG 1630

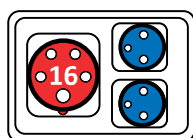

ROSPG 1631

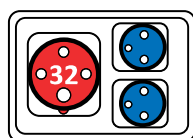

ROSPG 3230

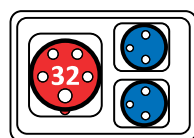

ROSPG 3231

ROSPG s držiakom - IP 67

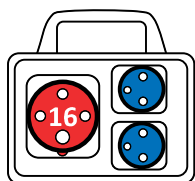

ROSPG 1630 D

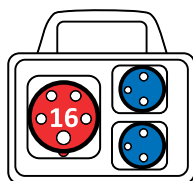

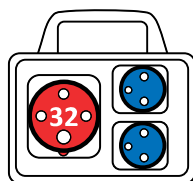

ROSPG 1631 D

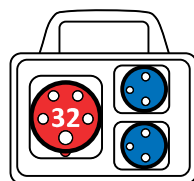

ROSPG 3230 D



ROSPG 3231 D

POČET ZÁSUVIEK			POISTKA	TYP	
DOMOVÉ	PRIEMYSELNÉ			VYHOTOVENIE	
250V	400V			 4 POLOVÉ 3 P+PE	 5 POLOVÉ 3 P+N+PE
16A	16A	32A	F10H/250V		
ROS – IP54					
2	1			ROSP 1630	ROSP 1631
2		1	2	ROSP 3230	ROSP 3231
4				ROSP 4VZ*	
ROS S DRŽIAKOM – IP54					
2	1			ROSP 1630 D	ROSP 1631 D
2		1	2	ROSP 3230 D	ROSP 3231 D
4				ROSP 4VZ D*	
ROSPG – IP67					
2	1			ROSPG 1630	ROSPG 1631
2		1	2	ROSPG 3230	ROSPG 3231
ROSPG S DRŽIAKOM – IP67					
2	1			ROSPG 1630 D	ROSPG 1631 D
2		1	2	ROSPG 3230 D	ROSPG 3231 D

Podľa požiadavky užívateľa je možné dodať akékoľvek ďalšie prípustné kombinácie.

* Tieto typy obsahujú len 3P zásuvky.